



ModelMaker H120
laser scanner

MCAx S portable
CMM arm



Portable precision,
detail & productivity

HANDHELD SCANNING

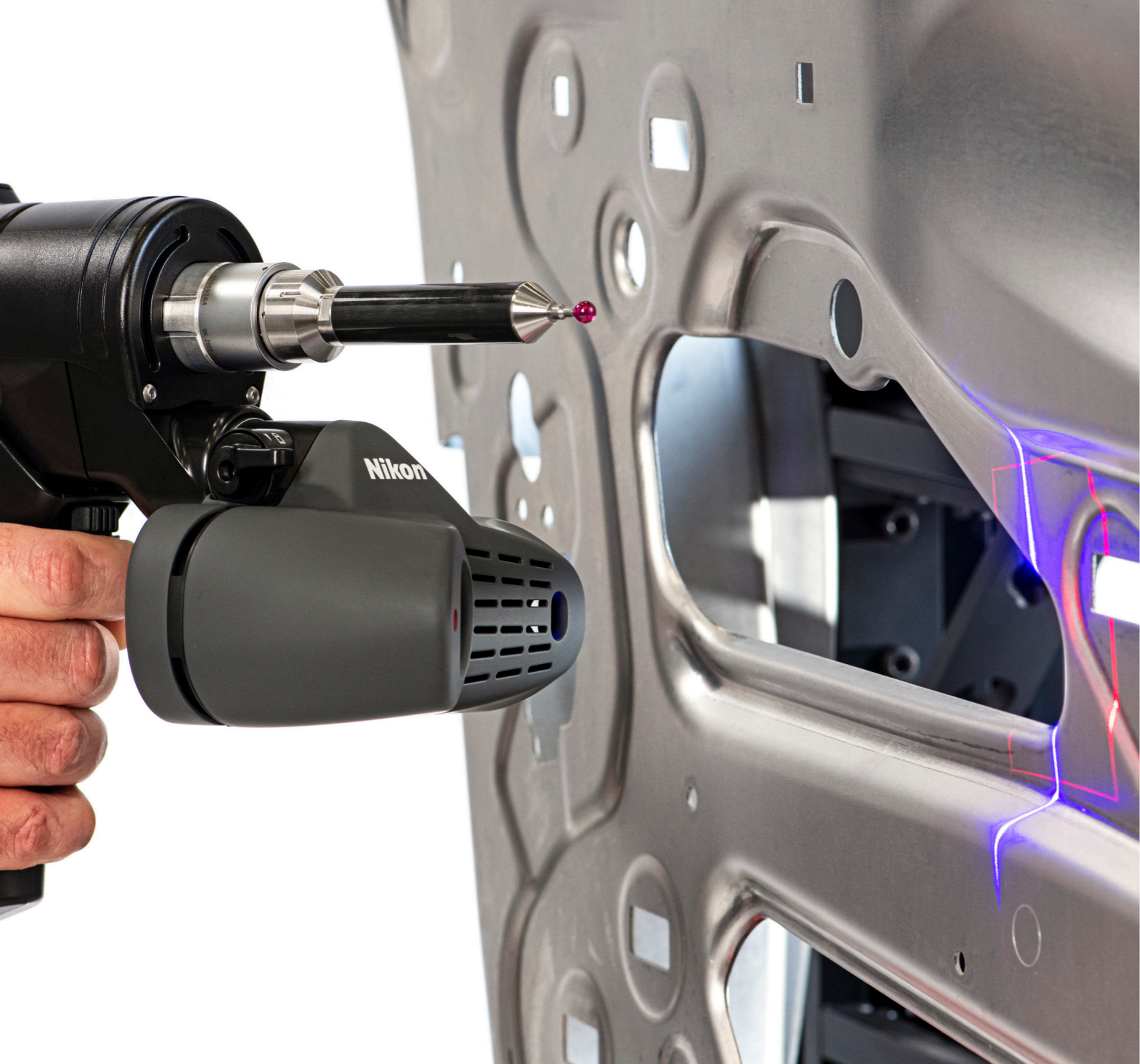

Ultra-fast high-definition 3D scanning

Nikon Metrology's premium ModelMaker H120 laser scanner and MCAx S 7-axis articulated portable CMM arm form a leading-edge 3D measurement solution, enabling users to accelerate their time-to-market and streamline their manufacturing processes.

ModelMaker H120 innovations such as bespoke Nikon optics, advanced calibration and patented automatic optimisation of settings for every single measured point with no reduction in speed; guarantee high productivity and superior non-contact measurement of freeform and geometric surfaces without compromising on small details – no matter the size or material.

The MCAx S arm range comprises three performance levels at six different sizes and is compatible with tripods and magnetic bases for use in the metrology lab, on the shop floor or in the field. Unrestricted reach in and around parts at extreme precision while delivering high-speed wireless scanning provides versatility, simple operation and efficiency in any environment.



System certification to the comprehensive ISO quality standards alongside seamless integration and workflow with many leading metrology software suites drives user confidence that the measurement results are the highest quality for their application, regardless of industry.

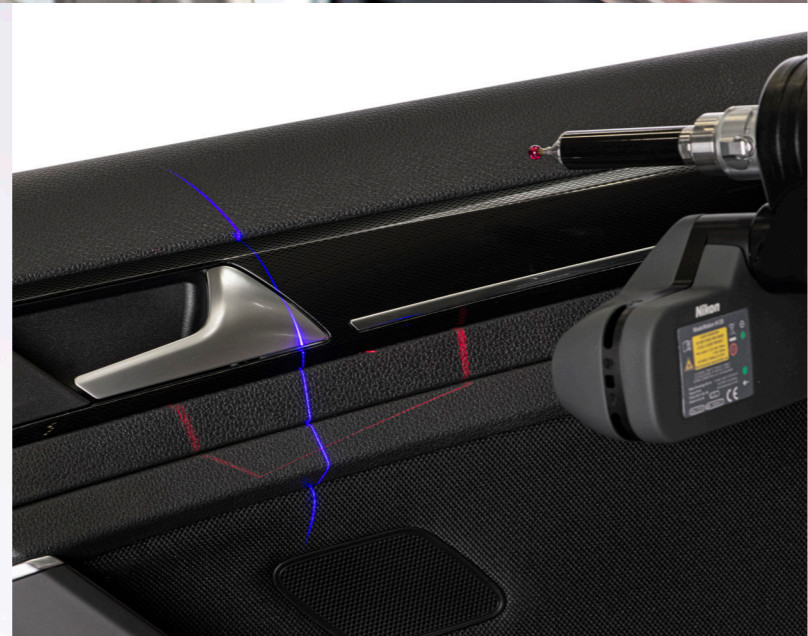

DETAIL, ACCURACY, PRODUCTIVITY

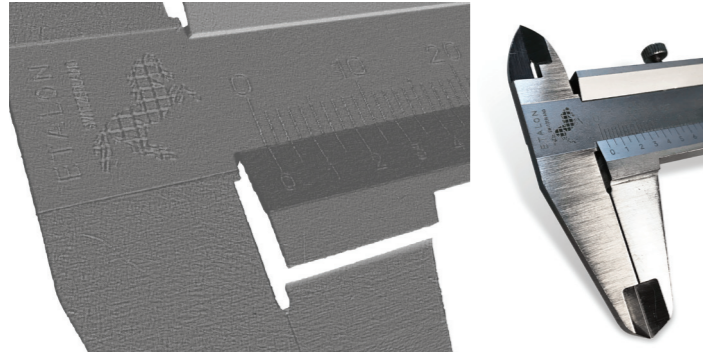

CLASS-LEADING HANDHELD SCANNING

Seamless high performance inspection is realized through the class-leading capabilities of the ModelMaker H120 scanner to measure small details with high accuracy on large parts in a short timeframe. The accuracy, ease-of-use and flexibility of the 7-axis MCAx S arm delivers precise probing in parallel to scanning.

- ✓ Measure sharp edges and tiny details
- ✓ Inspect large surface areas with speed
- ✓ Freeform or geometric surfaces
- ✓ Scan around and even inside large complex shapes

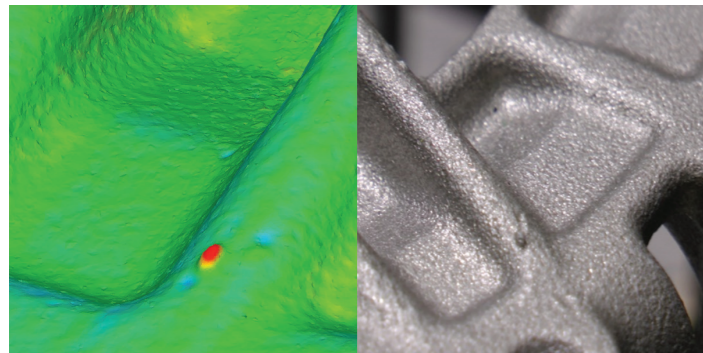

MEASURE ANY MATERIAL

Nikon's innovative and proven dynamic laser power control allows for almost any combination of materials to be scanned together without expert user knowledge. Paired with the MCAx S arm's ability to have scanner and probe available simultaneously, tactile inspection of hidden details is possible.

- ✓ ESP real-time laser optimisation for every point
- ✓ Scan matte, reflective, black, near-transparent and multi-coloured surfaces at the same time
- ✓ No speed reduction for difficult materials



STABILITY AND PORTABILITY

With quick connection to a variety of mountings, users can define exactly where and for what application the system is used. Taking the system to the part that will be measured or on the production line saves valuable time and organization, allowing users to get the results they need quickly.

- ✓ Use in any industrial environment
- ✓ Thermally stabilised with zero warm up time
- ✓ Easy transportation
- ✓ Wireless full speed scanning
- ✓ Choice of tripods, bases and stands

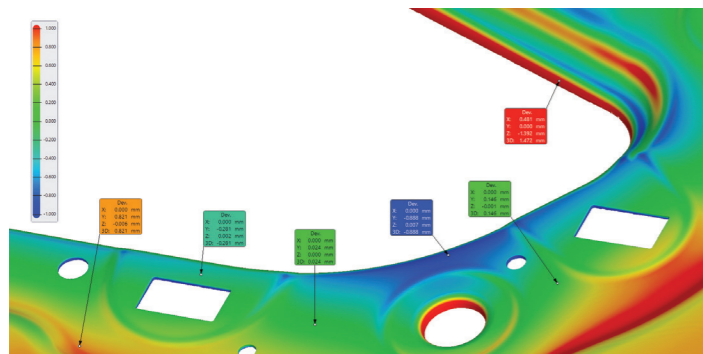

PRECISION MEASURING

To provide total confidence in the solution, every delivered combination of ModelMaker H120 and MCAx S arm receives a system certification of the scanning performance according to ISO 10360-8 Annex D.

- ✓ Class-leading real-life measurements
- ✓ Full productivity measuring difficult materials
- ✓ System accuracy from 0.041 mm
- ✓ ISO certification
- ✓ Leading software integrations

ModelMaker H120 | MCAx S

Laser scanner and portable CMM arm system

The MCAx S arm and ModelMaker H120 laser scanner combine to optimise production workflow through rapid, reliable and accurate analysis of product dimensions, both freeform and geometric.

Unprecedented levels of detail and precision for a portable, shop floor suited solution – regardless of user experience.



ModelMaker H120

Laser scanner



SIMPLE SETUP

Integrated repeatable quick-release locking connector
 Plug & play – no network configuration needed

DETAIL AND SPEED

450 Hz frame rate
 2,000 points per line
 35 µm point spacing
 120 mm laser line
 0.007 mm accuracy

MULTI-PROBING READY

Large probe clearance
 Intelligent auto-switching between scanner and probe

INSTANT PRODUCTIVITY

Zero warm up
 Temperature compensated

DATA COVERAGE

Low noise blue laser
 ESP4 real-time laser optimisation

INNOVATION

Premium Nikon lens
 Contrasting full FoV red laser range finder

ENHANCED USER EXPERIENCE

Innovative functionality such as thermal compensation, integrated locking connector, contrasting full field of view projector, excellent tactile probe clearance and a compact size give the user all the feedback and assurance needed to concentrate purely on the measurement task.

Superior accuracy ensures the ModelMaker H120 stands far apart from similar technology, further pushing the accepted boundaries of handheld laser scanners.

START MEASURING IMMEDIATELY

Simple system set-up, immediate boot-up and no need for scanner warm-up; combined with the structural rigidity, thermal stability and absolute encoder technology of the MCAx S arms allows users to switch on and start confidently collecting accurate data straightaway.

UNCOMPROMISING PERFORMANCE

The ModelMaker H120 guarantees fast data collection over a large area with no compromise on small details – offering great flexibility in a single solution even when cycle time is critical, no matter the type of parts measured.

The MCAx S arm further enhances the user experience by adding the ability to scan truly cable free, through high-speed Wi-Fi connectivity and battery power with absolutely no reduction in productivity.

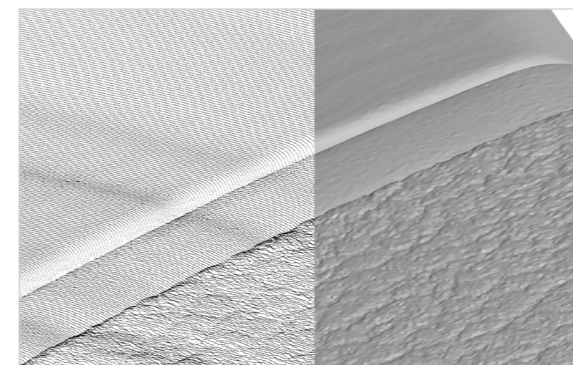

MEASURE THE MOST CHALLENGING MATERIALS

Patented Enhanced Sensor Performance (ESP4) provides automatic real-time adjustment of the laser intensity for every single point in the same image frame.

- ✓ Ensures full data across materials with completely different optical properties.
- ✓ Measure high contrast reflectivity changes, absorptive coatings, near-mirrored finishes and near-transparency.
- ✓ No reduction in data rate, even when scanning wirelessly.

Intelligent reflection control allows measurement of very shiny or polished materials while unwanted reflections are removed.

Refined over many years and proven in all Nikon laser scanners, ESP4 gives the benefits of per-point laser optimisation found in flying-spot scanners, but in a sensor with no moving parts that could suffer from acceleration effects, which is not limited by poor point resolution and slow frame rates.

ESP4 does not rely on combining scan data points derived from several full frame images taken at different exposures and at slightly different positions. Making it more accurate than competing HDR technologies, which themselves often require reduced frame rates to operate.

NIKON OPTICAL ADVANTAGE

Expertly crafted bespoke in-house lens design enables the smallest structural resolution and lowest noise measurements in handheld scanning.

The specially-developed Nikon optics and hand-assembled low-speckle blue laser source technology provide incredible details such as surface texture, very sharp edges and even dust, scratches and abrasions.

Nikon does not use interpolation techniques to increase data rates...

...Every point is an optically measured point.



REVEAL THE SMALLEST DETAIL

The incredible dynamic range and pin sharp optics combine with the flexibility of movement and accuracy of the MCAx S arm to provide insight other solutions cannot deliver.

Geometric features are more exact than ever due to the clarity of data on thin-walled parts, giving more reliable feature fitting or trim edge extraction than can be achieved using tactile CMM technology.

This reveals a level of detail far beyond traditional position, size and orientation – even revealing how a part was machined or stamped.

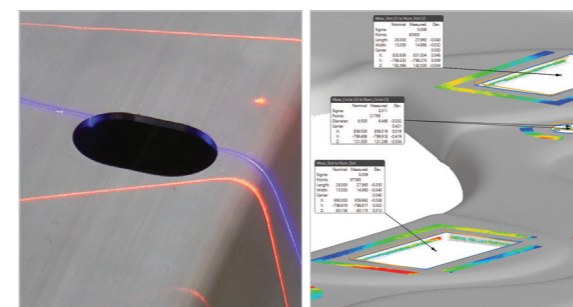

MCAx S

Portable CMM arm

MCAx S is a precise, reliable and easy-to-use 7-axis portable articulated coordinate measuring arm able to measure around and even inside large parts without constraints.

It is the perfect partner for the industry leading ModelMaker H120 laser scanner and has seamless integrations to a variety of industry accepted metrology software suites.

This solution's accuracy, capability and portability make it the optimal measurement companion in the metrology lab, on the shop floor or in the field.

The arm can be equipped with a wide range of tactile probes alongside laser scanning for a variety of tasks. Its flexibility makes this measurement arm the ideal solution for the widest range of measurement tasks.

FLEXIBILITY

The MCAx S ranges in size from 2.0 to 4.5 m and three performance levels for user choice of the optimal system configuration for the application.

S suits entry-level metrology and budget, S+ mixes high performance with value and S++ gives no-compromise accuracy.

- MCAx S++ Ultra-high accuracy
- MCAx S+ High accuracy
- MCAx S Standard accuracy
- Size

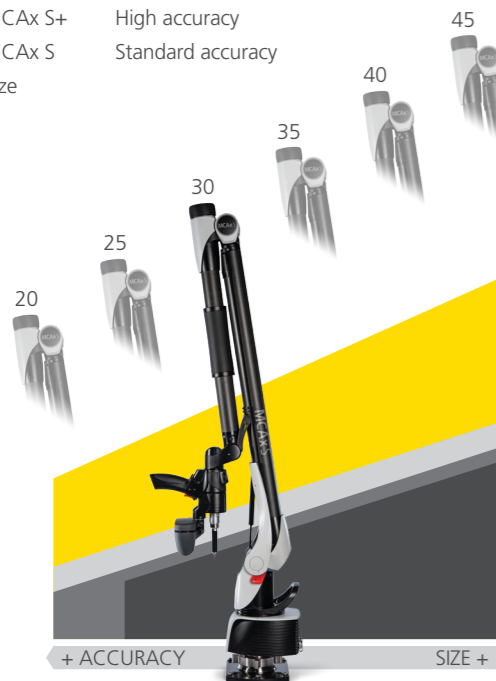

STRESS-FREE

Infinite joint rotation, low resistance rotating grips and integrated counterbalance deliver lightweight freedom of movement with minimal user fatigue.

INSTANT PRECISION

High performance specifications such as length accuracy from 0.029 mm and feature size from 0.010 mm can be realised without waiting for the system to reach working temperature.

Absolute encoders remove the need to reference every axis and simple plug and play connectivity means there is no need to reconfigure default PC Ethernet or Wi-Fi network settings.

Carbon fibre materials along with rigid structural design offer temperature stability and long-term mechanical strength in any environment.



WIRELESS SCANNING

With the optional Wireless Control Pack, Wi-Fi connectivity and dual hot-swappable batteries augment the system true cable-free usage.

Scan wirelessly for up to 4 hours using the ModelMaker H120 with no reduction in data speed or quality.

Standard Control Pack connectivity included with every system gives robust single cable Ethernet Gigabit data transfer and AC power.



INTELLIGENT MULTI-PROBING

Seamless integration of the ModelMaker H120 laser scanner provides a high-performance scanning solution.

Automatic pre-selection and switching between scanner and probe enhances productivity. Simply choose to probe a feature and the system automatically selects the connected probe. Choose to scan and the system automatically selects the scanner.

Integrated LED wrist screen, multi-functional buttons and repeatable scanner and touch probe mounting.

For tactile versatility, a large range of probes is available to complement the system's three standard probes. All probes are automatically recognised.

- Straight probes up to 350 mm long
- Angled probes for hard-to-reach places
- Touch-trigger
- Build-your-own probe kits and adapters

ISO CERTIFICATION

Precision is defined by system scanning and arm probing accuracy certified to the comprehensive ISO 10360-8 Annex D and ISO 10360-12 standards to meet modern industry expectations.

Each system is provided with artefacts for interim user verification to confirm confidence in measurements.

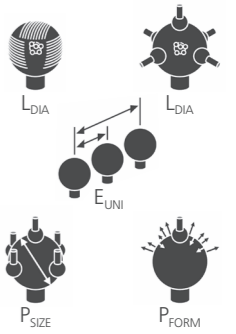

CONVENIENCE

Incorporating all the essential hardware elements needed for set up, measurement and accuracy verification, the precision cut foam inside the shock-proof wheeled flight case gives optimal protection to both the scanner and arm.



CONFIDENCE

Secure locking of the arm for reassurance during repositioning between measurements.

Optimised wrist docking for a safe but ready-to-measure position protects the scanner and probe.



USER FEEDBACK

Bluetooth® external audio connectivity along with integrated visual, audio and haptic indicators for clear system feedback.



MOUNTING VERSATILITY

The integrated 3.5 in x 8 adapter gives freedom to choose exactly the right mounting for the application, providing secure installation within seconds:

- Bolt-down, magnetic or vacuum bases for table-tops
- Heavy duty mobile or fixed stands for shop floors
- Portable tripods for measurement on different sites



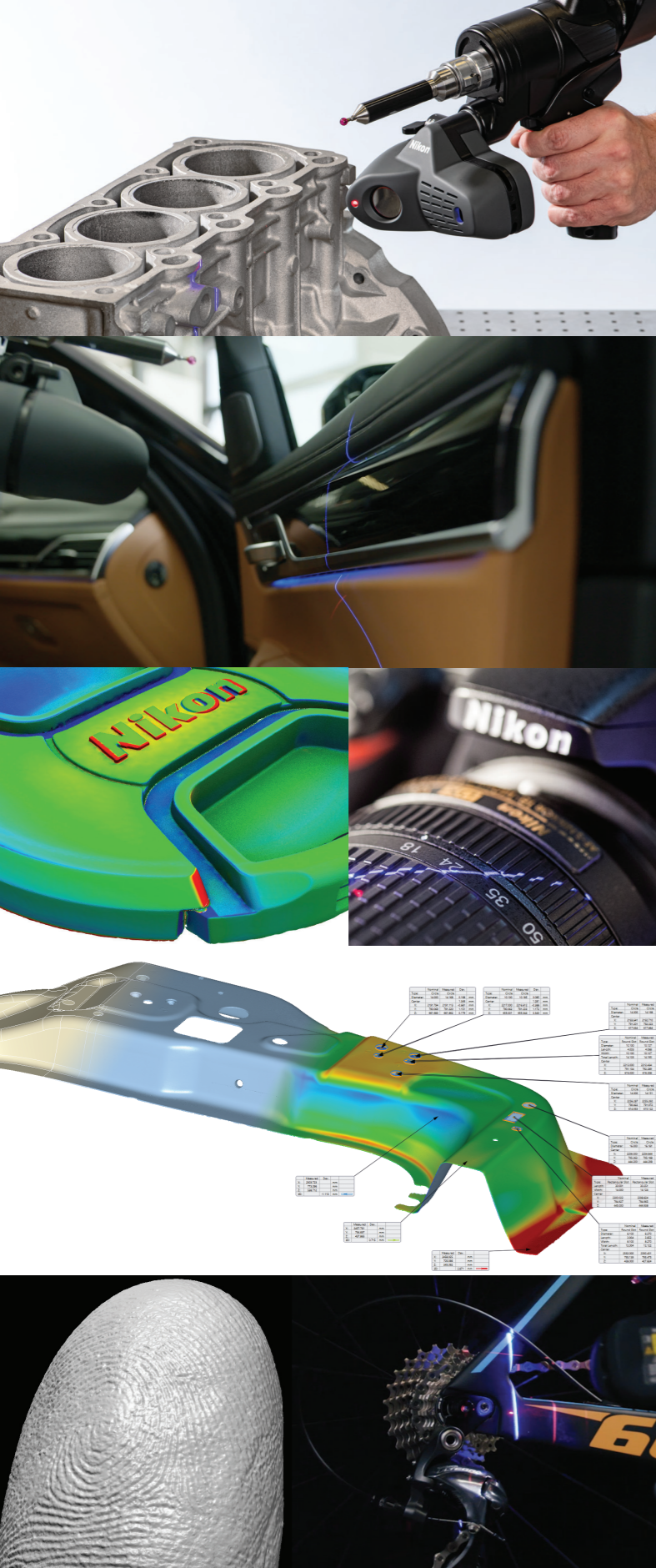

Applications

Used to optimise production workflow through rapid, reliable and accurate analysis of product dimensions – both freeform and geometric – this solution has proven to be an invaluable tool across many industries and workplaces from the shop floor to the metrology lab.

Able to robustly measure almost any material and with the flexibility to inspect parts of sizes ranging from a few millimetres to several metres and more allows the solution to span almost any industry or educational need.

In combination with comprehensive industry accepted point cloud inspection or reverse engineering application software of your choice - time for measurement, analysis and design is compressed by rapidly diagnosing production issues.

This enables delivery of your products faster and with greater confidence by meeting the highest quality standards.

Specifications

MODELMAKER H120

Accuracy ¹	0.007 mm
Max. stripe width	120 mm
Measuring range	100 mm
Min. stand-off	80 mm
Min. point resolution	0.035 mm
Max. frame rate	450 Hz
Max. points per stripe	2,000 (non-interpolated)
Laser power adjustment	ESP4 real-time per point
Warm up time	0 s
Weight	0.5 kg
Laser power	Class 2, 450 nm
Field of View indicator	Full FoV
Compliance	CE
Arm attachment	Integrated

ISO 10360-8:2013 Annex D
Every ModelMaker H120 and MCAx S system is tested in combination according to this standard to give a clear understanding of the system scanning performance



Articulated location error, optical
L-Dia.5x25:Art:ODS
Defines the repeatability of the system (arm with optical sensor) measuring a calibrated sphere from different arm articulations and different orthogonal scan vectors in various locations in the arm volume. The largest diameter minimum circumscribed sphere encompassing each location's scanned sphere centres is reported.

¹ Certified laser scanner (sensor) accuracy is determined by scanning a plane from various directions, each time using the entire sensor field of view depth, width and diagonal. The result is the maximum 1σ deviation of the scan data to fitted plane features.

LASER RADIATION
DO NOT STARE INTO BEAM
CLASS 2 LASER PRODUCT
Max output = 2.01 mW 450nm
1 mW 650nm
IEC 60825-1 Edition 3.0 2014
Read instruction manual before use



MODELMAKER H120 WITH MCAx S

	SCANNING				PROBING		Reach ² (m)	Weight ³ (kg)
	L _{DIA} (mm)	E _{UNI} (mm)	P _{SIZE} (mm)	P _{FORM} (mm)	L _{DIA} (mm)			
MCAx S25++	0.043	0.029	0.011	0.023	0.044	3.25	9.8	
MCAx S30++	0.056	0.053	0.018	0.035	0.076	3.75	10.1	
MCAx S35++	0.068	0.064	0.022	0.041	0.092	4.25	10.4	
MCAx S40++	0.080	0.078	0.028	0.046	0.110	4.75	10.7	
MCAx S45++	0.121	0.104	0.044	0.060	0.125	5.25	11.0	
MCAx S20+	0.041	0.029	0.010	0.021	0.038	2.75	9.5	
MCAx S25+	0.047	0.031	0.012	0.025	0.048	3.25	9.8	
MCAx S30+	0.064	0.057	0.020	0.038	0.083	3.75	10.1	
MCAx S35+	0.078	0.069	0.024	0.045	0.099	4.25	10.4	
MCAx S40+	0.089	0.084	0.030	0.050	0.120	4.75	10.7	
MCAx S45+	0.141	0.113	0.048	0.065	0.140	5.25	11.0	
MCAx S20	0.059	0.043	0.016	0.033	0.054	2.75	9.3	
MCAx S25	0.065	0.048	0.023	0.043	0.060	3.25	9.6	
MCAx S30	0.082	0.078	0.034	0.058	0.090	3.75	9.9	
MCAx S35	0.099	0.092	0.042	0.067	0.115	4.25	10.2	
MCAx S40	0.118	0.114	0.051	0.084	0.140	4.75	10.5	
MCAx S45	0.163	0.158	0.078	0.106	0.168	5.25	10.8	

Working temperature +5 to +40 °C Relative humidity 10 to 90% non-condensing Power requirement 110 to 240 V AC (50 to 60 Hz) ² Maximum diametrical reach (to scanner FoV)
Storage temperature -30 to +70 °C Operational elevation 0 to 2,000 m Compliance CE ³ System weight including scanner

ISO 10360-12:2016

Every MCAx S arm is certified to four distinct tests within the standard that give clear understanding of the overall tactile probing performance



Length measurement error, unidirectional
E_{UNI}:0:Tact.AArm
Defines the maximum permissible error of over 100 uni-directionally measured lengths, representing the global (or volumetric) accuracy.



Probing size error, tactile
P_{SIZE}:Sph.1x25::Tact.AArm
Defines the maximum permissible error of sphere diameter, representing probed feature size accuracy.



Probing form error, tactile
P_{FORM}:Sph.1x25::Tact.AArm
Defines the maximum permissible error in form measurement of a sphere, representing probed feature noise.



Articulated location error, tactile
L-Dia.5x5:Art:Tact.AArm
Defines the maximum permissible error in sphere location measured from different arm poses, representing probed feature repeatability.

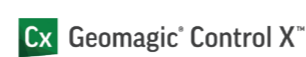

Specifications subject to change without notice



NIKON METROLOGY NV

Geldenaaksebaan 329
B-3001 Leuven, Belgium
Tel: +32 16 74 01 00 Fax: +32 16 74 01 03
Sales.NM@nikon.com

NIKON CORPORATION

Shinagawa Intercity Tower C, 2-15-3, Konan,
Minato-ku, Tokyo 108-6290 Japan
Tel: +81 3 6433 3701 Fax: +81-3-6433-3784
www.nikon.com/products/industrial-metrology/

ISO 14001 Certified
for NIKON CORPORATION

ISO 9001 Certified
for NIKON CORPORATION
Industrial Metrology Business Unit

NIKON METROLOGY EUROPE NV
Tel: +32 16 74 01 01
Sales.Europe.NM@nikon.com

NIKON METROLOGY GMBH
Tel: +49 6023 91733-0
Sales.Germany.NM@nikon.com

NIKON METROLOGY SARL
Tel: +33 1 60 86 09 76
Sales.France.NM@nikon.com

NIKON METROLOGY, INC.
Tel: +1 810 2204360
Sales.NM-US@nikon.com

NIKON METROLOGY UK LTD.
Tel: +44 1332 811349
Sales.UK.NM@nikon.com

NIKON MÉXICO - METROLOGY
Tel: +52 (442) 688 5067
Sales.NM-MX@nikon.com

NIKON INSTRUMENTS (SHANGHAI) CO. LTD.
Tel: +86 21 6841 2050 (Shanghai branch)
Tel: +86 10 5831 2028 (Beijing branch)
Tel: +86 20 3882 0551 (Guangzhou branch)

NIKON SINGAPORE PTE. LTD.
Tel: +65 6559 3651

NIKON INSTRUMENTS KOREA CO. LTD.
Tel: +82 2 2186 8400

NIKON SALES (THAILAND) CO., LTD.
Tel: +66-2633-5100

NIKON INDIA PRIVATE LIMITED
Tel: +91-124-4688500